

“Equi-Flow”

Model AFLE - Automatic Flow Limiter for Shower Hoses - Datasheet

Description

Automatic Shower Flow Limiter with integral variable orifice cartridge, which limits the flow of water according to one of three selected flow rates; 0.13 Lt/s (white) - most common, 0.1 Lt/s (black) or 0.17 Lt/s (blue).

Fitted between the tap and hose “Equi-Flow” limits the amount of water to each shower - ensuring even distribution. This prevents some showers (e.g. on the ground floor) from receiving excessive flow whilst others (e.g. on the top floor) receive very little.

Saves water and energy making it ideal for multiple occupancy buildings such as hotels, flats and student accommodation.

Easily installed - simply screw onto the inlet of shower hose. Supplied with rubber sealing washer.

Double Check Valve

The “Equi-Flow” Shower Limiter can be supplied separately or as an assembly with the ED235 Double Check Valve in a 21 mm long housing. The introduction of the Double Check Valve means the assembly is suitable for backflow protection from Fluid Category 3 risks i.e. domestic bath / shower hoses. This includes hotels but excludes nursing homes and hospitals.

See Double Check Valve (model ED235) datasheet.



ED235WT – Double Check Valve and Automatic Shower Flow Limiter with 0.13 Lt/s cartridge

Connection Pipes

DN15 Female inlet, DN15 male outlet.

Specification

Pressure 16 bar max.
Temperature Continuous - 65° C
Intermittent - 90° C

Approval KIWA UK A040760

Materials

Body Brass – chrome plated
Cartridges POM
Elastomers NBR

Applications

Primarily intended for flexible shower hoses.

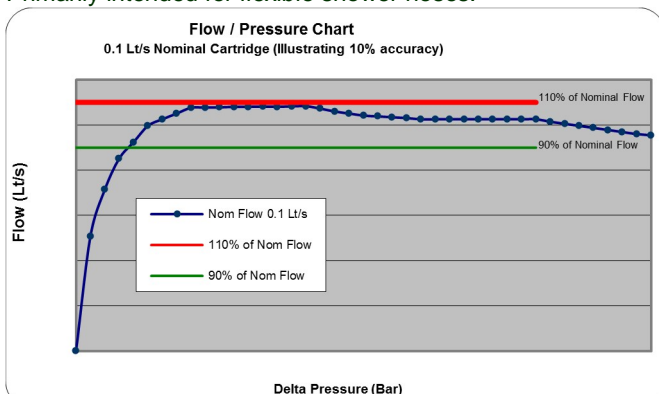

AFLE15FMWT – Automatic Flow Limiter for Shower Hoses with 0.13 Lt/s cartridge for limiting flow of water

Water Regulations

It is an offence, under Regulation 3 to use a fitting, which **causes or is likely to cause**, waste, misuse or undue consumption of water supplied by the water company.

Regulation 3.2 (i) states:-

- (2) No water fitting shall be installed, connected, arranged or used in such a manner that it causes or is likely to cause –
(i) waste, misuse, undue consumption or contamination of water supplied by a water undertaker

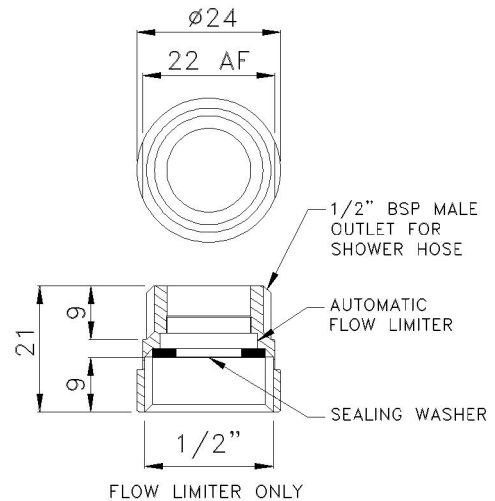

Available as DN15 (1/2") only.

Codes and Descriptions

Size	Code	Description
DN15	AFLE15FMBK	Equi-Flow Shower Limiter Black 0.10 Lt/s Chrm
DN15	AFLE15FMWT	Equi-Flow Shower Limiter White 0.13 Lt/s Chrm
DN15	AFLE15FMBl	Equi-Flow Shower Limiter Blue 0.17 Lt/s Chrm

Arrow Valves Ltd

Tel: 01442 823123 Fax: 01442 823234

www.arrowvalves.co.uk
info@arrowvalves.co.uk

Arrow Valves Ltd reserve the right to change specifications, design and materials at any time without notice.
All unit-less dimensions in mm.
© Copyright Arrow Valves Ltd 2001-2012

