

# Low Loss Double Check Valve

## Model ED132 – DZR Brass with Flat-Faced Connections - Datasheet

### Description

Double Check Valves (ED device) with DZR brass valve bodies suitable for most pipe materials. Flat-faced connectors allow direct connection to the pipe without the need for sealants or additional adapters.

Oversize, high-flow Cartridges provide **exceptionally** low head-loss characteristics. E.g. pressure drop for the 15 mm valve at 3 m/s pipe velocity is just 0.1 bar compared with 0.5 bar for a conventional valve. This is especially important when used on non-boosted systems since mains water pressures are being lowered down to 1.0 bar (@ 9 lt/min) in many regions.

Flat-faced union connectors with soft washers allow valves to be easily installed to new or existing pipes without the need to spring pipes apart. This system allows for numerous pipe systems – see below. Valves are demountable.

Sprung-loaded Cartridges with resilient seats provide positive closure, no water hammer and low opening pressure.

### Pipe Connectors

These are available from Arrow Valves -

- Copper – Solder Unions or Press-Fit (Mapress/Yorkshire)
  - Tectite® Push-Fit - 15 (non-union) & 22 mm union
- Stainless – Use Press-Fit Unions (Mapress/Yorkshire)
- Friatherm – Use C-PVC Unions
- Steel – Use Male Unions BSP

### Specification

- Pressure 16 bar max.
- Test Pressure 16 bar (reverse)
- Temperature max. Continuous - 65° C Intermittent - 90° C
- Approval (complete) KIWA UK 0810701

### Materials

- Body CZ132 DZR Brass
- Circlips, Springs Stainless steel
- Cartridges POM
- Elastomers NBR

### Applications

- Backflow prevention for fluids in Categories 1 – 3
- Supply to flats and apartments – see *Branch Valve*
- Hose union taps – see *our range*
- Domestic washbasins, baths and showers
- Water softening plant (common salt only)
- Primary heating circuits (houses only) - see *CA Device*
- Hose union taps (houses only – inside property)



Model ED22SU132  
22 mm Double Check Valve with Solder Unions

### Water Regulations

Double Check Valves are suitable for backflow protection of Fluid Category 3 risks as defined in the new Water Regulations – July 1999. An ED device should be fitted as whole site protection to the supply of separately occupied premises (whether or not they are separately chargeable). In other cases, an ED device should be fitted at points of use – i.e. one per appliance (Schedule 2, paragraph 15). Refer to *Branch Valve data sheet*.

Valves should not be buried. Test points between the check valves are no longer required. Hose union taps with integral check valves are no longer acceptable for new installations.

Many applications listed as Fluid Category 3 (requiring DCV) become Fluid Category 4 (requiring RPZ – available from Arrow Valves) when used for commercial (non house) situations – e.g. heating systems.

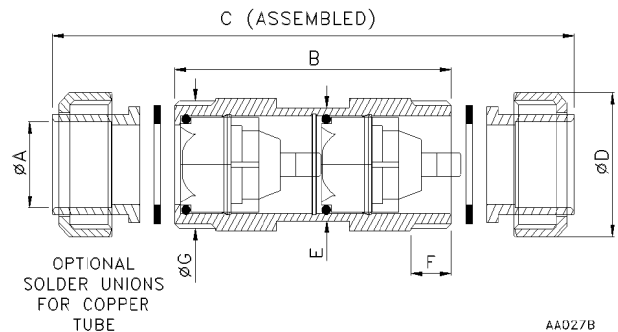

15 & 22 mm now available with Tectite® Push-Fit connections offering ease of installation (no tools required) and a reliable connection

ØA	B	C (SU)	ØD	E	F	G
15	50	93	33	23	10	¾"
22	78	133	41	29	12	1"
28	105	170	52	37	14	1¼"
35	120	195	60	45	16	1½"
42	139			55	20	2"
54	139			65	22	2½"

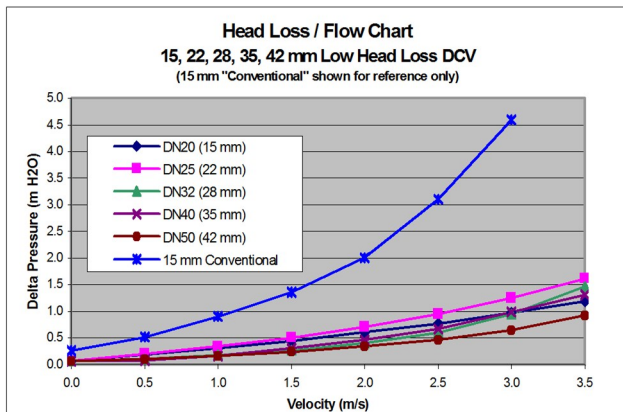

**Notes**  
Velocity based on flow of water through the bore of copper tube table X. "Conventional" is 15 mm compression valve with Watts CO015 cartridges. See Flow Table to find the actual flow rate.

### Codes and Descriptions

Sizes	Code	Description
15,22,28,35,42,54 mm	EDsizeSU132	132 Low Loss Double Check Valve c/w SU
DN20,25,32,40,50,65	EDsizeMP132	132 Low Loss Double Check Flat-Face
15 mm	ED15TU132	132 Low Loss Double Check Tectite Union
22 mm	ED22T132	132 Low Loss Double Check Valve Tectite

#### Notes

Other pipe connectors available – please contact us.  
The Flat-Faced Union design has a thread size larger than the nominal pipe. E.g. 15 mm valve has a ¾" male thread.

#### Arrow Valves Ltd

Tel: 01442 823123 Fax: 01442 823234  
www.arrowvalves.co.uk  
info@arrowvalves.co.uk

Arrow Valves Ltd reserve the right to change specifications, design and materials at any time without notice.  
All unit-less dimensions in mm.  
© Copyright Arrow Valves Ltd 2001-2012

